

Model	D	W	H	WT
DK-3LG-TRIC-2836-AM	24"	36"	22"-31"	20
DK-3LG-TRIC-2836-30	24"	36"	30"	20
DK-3GX-TRIC-2836-AO <i>Galaxy Desk</i>	24"	36"	22"-30"	26
DK-3LG-TRIC-2836-30	24"	36"	30"	26

SPECIFICATIONS

Columbia's Tri-cornered Desk is designed for inclusion, collaboration, individual learning, or teacher centered classroom environments. ADA model available in HPL with Edging or MDF with Duro Edge only.

Frame

- 1 1/8" diameter, 18 gauge steel tubing welded to a 10 gauge 4x5 Plate
- Welded 7/8" diameter, 16-gauge stretcher
- Insert is 1" diameter, 18 gauge tubing

Top

- 5/8"-1 1/4" thick, available in Hard Plastic, MDF or PB HPL
- Molded in dual pencil grooves
- 28" x 28"
- Solid plastic - ground hardwood flour, color pigment and melamine plastic resins, blended and compressed under heat and pressure (1900 psi)

Tubing

- 1008 -1010 steel
- Tubing - between 13 and 18 gauge

Height

- 30" fixed, 22"-31" adjustable

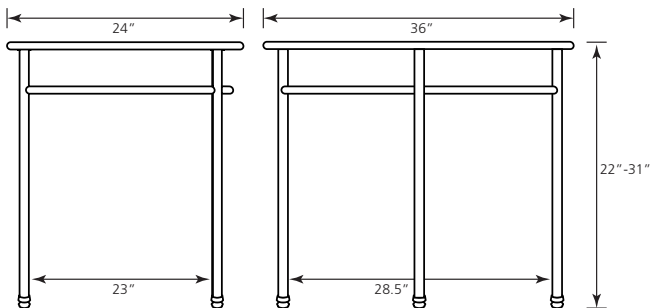
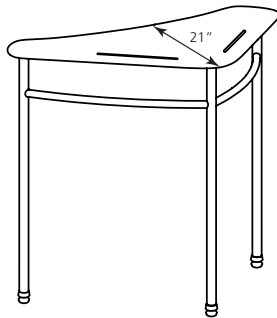

Shown in 30" height with wirebook basket and casters. Top Brushed Silver, Platinum frame

OPTIONS:



Legs

- Standard or Galaxy



Glides

Columbia glide options - Armored Glide, steel, felt base. Q Ball glides available upon request.

- 1" or 1 1/8" diameter swivel glides with hardened internal steel gripper
- 1/2" high shoulder glide firmly attaches to tubing
- Maximum 40°- swivel range
- Galaxy Adjustable 3" OD Nylon glides



Tri-corner Galaxy Desk
Shown in adjustable unit
Top Maple, Platinum/Chrome frame
2.2" OD Round Upper
2" Round Lower Frame

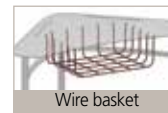
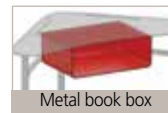
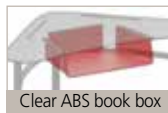

See-through Book Box

- Clear ABS ergo plastic
- Provides enhanced security and cleaning

Wire Book Basket

- Made of 1/4" round CRS carbon solid steel rods

Metal Book Box

- Fabricated from 20 gauge CRS carbon steel sheet with hemmed edges
- Available in sizes:
22 1/2" x 15 1/2" x 5" or
14" x 12" x 5" box



INDOOR ADVANTAGE GOLD FURNITURE

Tri-corner Desk

Hard Plastic Top Options



Laminate Top Options

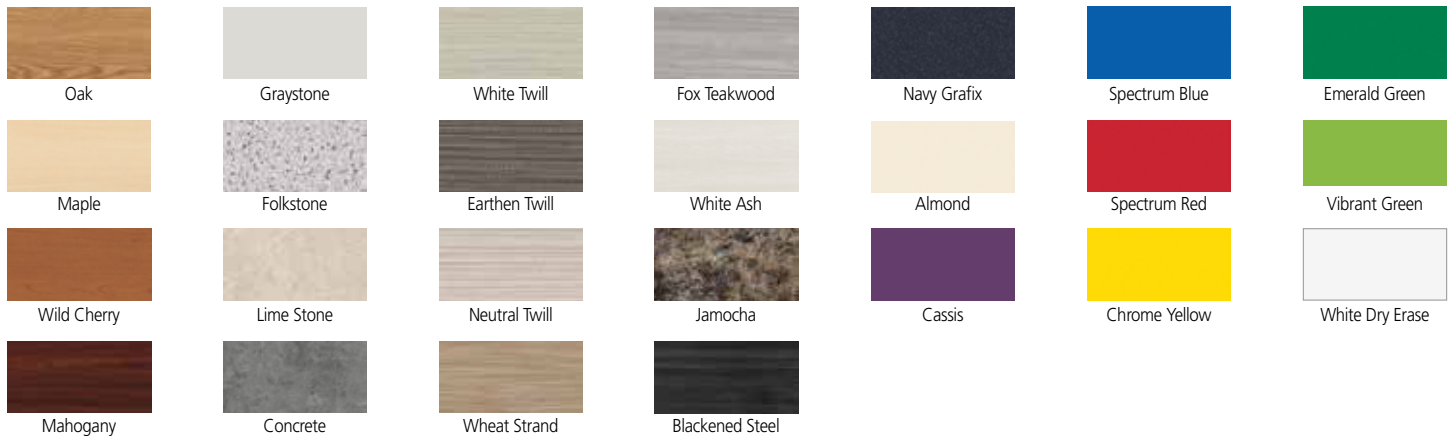

Edging Color Options



Frame Finish Options

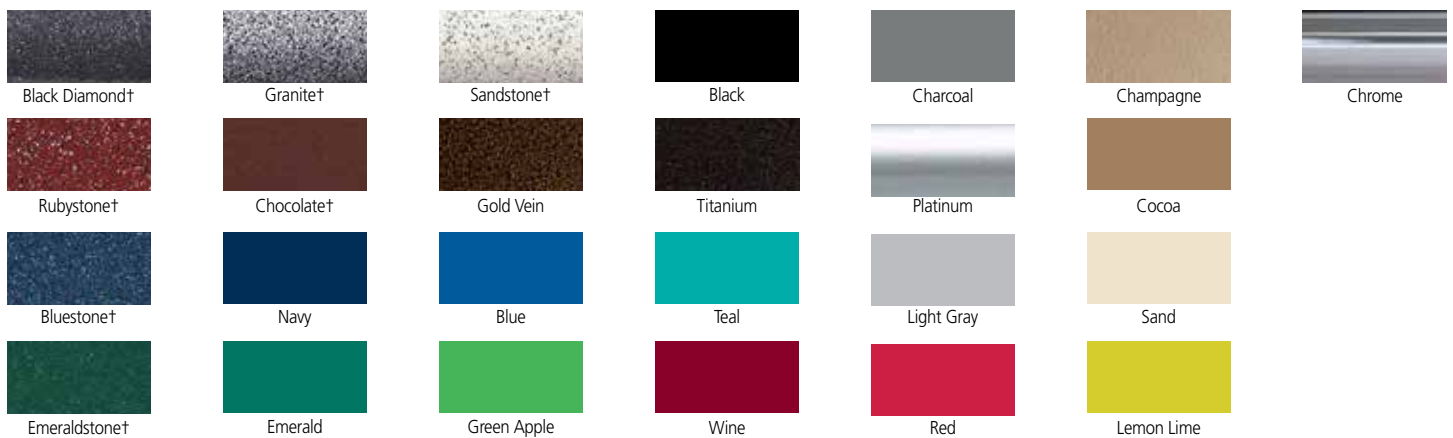

†Spec Flek

All non-standard colors subject to minimum quantities and upcharges.